



# **IN-GROUND LIFTING TECHNOLOGY**

SAVES SPACE, FOR  
OPTIMAL WORKING

made by MAHA  
 made  
in  
Germany



# TWO-POST LIFT WITH 3.5 t FLAT HEAD SUPPORT



- Lift with flat lifting heads, extensions and rubber pads
- Asymmetrical extensions with large lateral adjustability and low drive-on height
- Hot-dip galvanised support

Load capacity	3,500 kg
Cylinder distance	1350 mm
Extension range in latch steps	1400 – 2000 mm
Transverse support area	880 – 1820 mm
Rubber pad size	355 x 400 mm
Support height	60 mm
Crunch and pinch point protection	CE stop, audible signal
Power unit kW / V / A	3 / 400 / 16

- 1 Extensions with surrounding chamfered runners
- 2 Handles for easy adjustment of extensions
- 3 Modular system in different extension versions
- 4 Central beams in modern steel plate technology

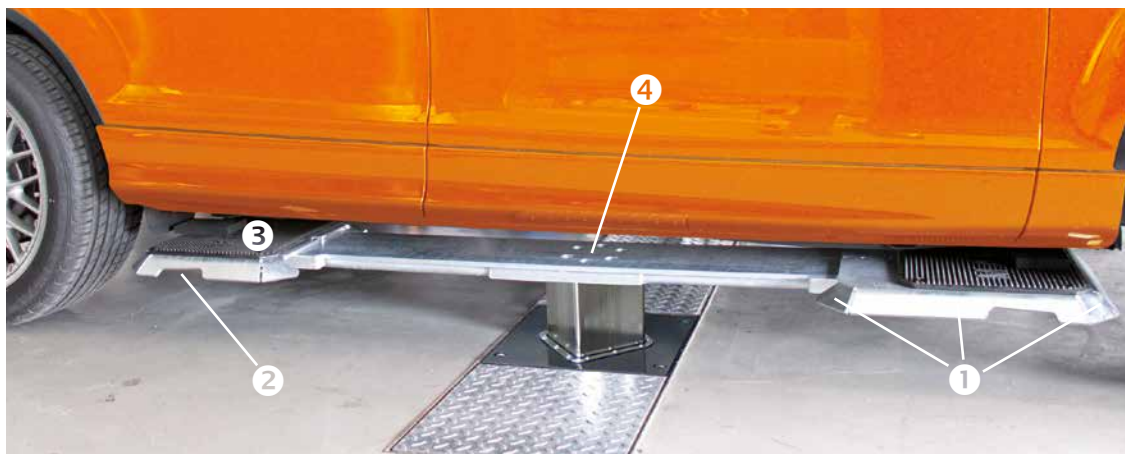

The extensions with special rubber pads are particularly suitable for quick and safe support of the vehicles.

## Extension designs

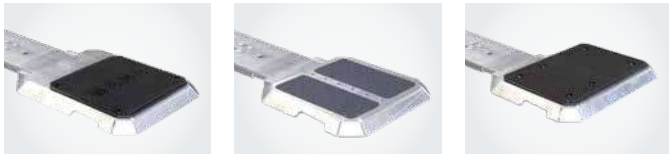

Extended support in driving direction with rubber pad, 1400 – 2200 mm (2x VZ 972452)

Flat head support with granular coating for low overall height (VZ 972423)

Large support plate for internal lifting points (VZ 972453)

## Support blocks for supporting individual vehicles

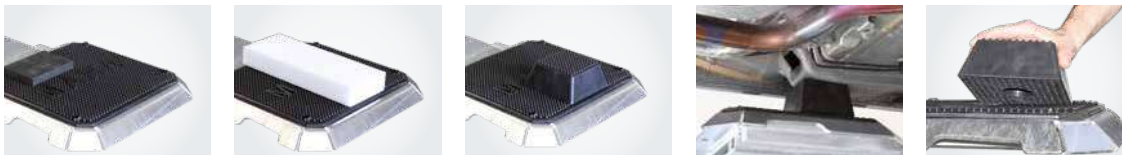

Flat rubber support, 20 mm high (VZ 97586)

Ductile plastic blocks (VZ 975069)

Pyramid block for highly accurate support and high freedom of movement underneath the vehicle.

Rubber plate and pyramid block matched by nub profile

## Flush-mounted flat head support



For easy driving over the flat head support. The D-ER mounting frame (VZ 972420) and the straight extensions (VZ 972519) help to install the flat head lift in a flush-mounted manner. This ensures quick lifting and lowering without adjusting the extensions.

## Working at the lift

Maximum use of space and complete door freedom let you work effectively on the vehicle

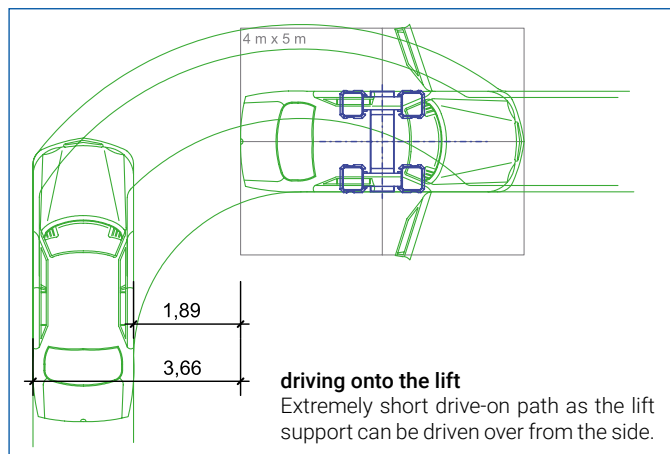

Flexible working under the vehicle

No risk of tripping and no uneven ground

# TWO-POST LIFT WITH 3.5 t SWING ARM SUPPORT

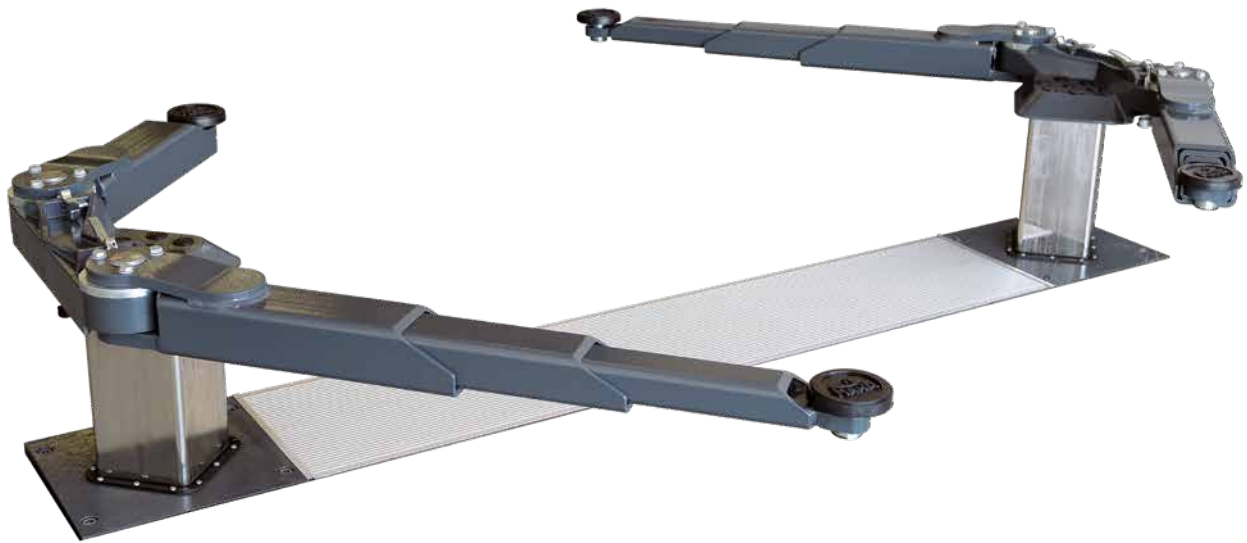

- Swing arm lift with continuously extendable support arms
- Support disc is height adjustable using a thread and plug-in system
- Support arm restraint is automatically self-releasing at ground level

Load capacity	3,500 kg
Lifting height, max.	1999 mm
Cylinder distance	2500 / 2300 / 1350 mm
Adjustable support discs	78 – 109 mm
Minimum support height	83 / 92 / 101 mm
Crunch and pinch point protection	CE stop, audible signal
Power unit kW / V / A	3 / 400 / 16

- 1 Easy driving onto the lift thanks to 270° swing range of the support arms
- 2 Support arm restraint can be operated from above
- 3 Continuously extendable, triple-telescopic support arms



Swing arm support with tool tray.

## Flexible support disc systems



Fine adjustment of the support disc in the 25 mm area thanks to small thread pitch

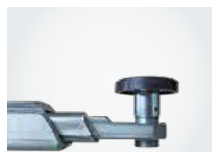
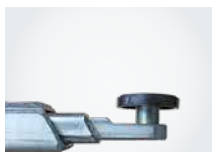

Support disc height extension by 50 mm (VZ 971220) or 100 mm (VZ 971221)

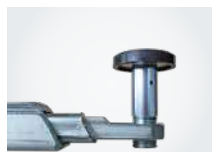

Support disc height extension by 150 mm (VZ 971222) or 200 mm (VZ 971223)



Great flexibility and safety thanks to support disc plug-in system



Support for round and V-shaped vehicle lifting points (VZ 971226)



Mandrel holder for holes in the vehicle frame (VZ 975601)



Frame slipping protection for positioning on rubber support discs (VZ 975050)

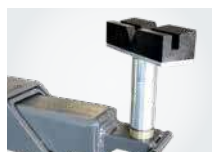

Vehicle support for G class without step plate (VZ 971227)



Vehicle support for G class with step plate (VZ 971520)

## Working at the lift

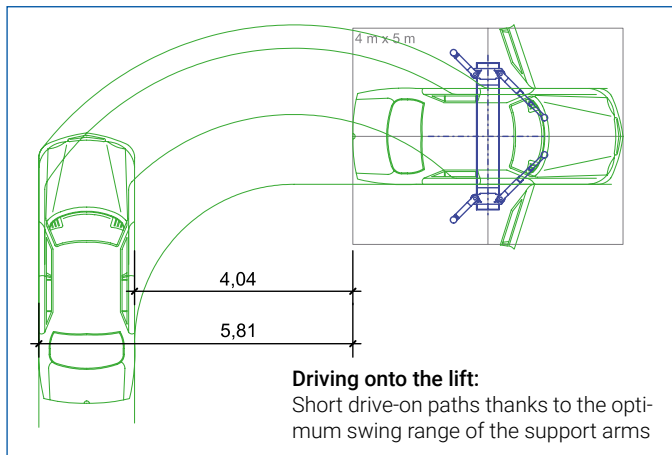

Maximum use of space and complete door freedom let you work effectively on the vehicle.

# TWO-POST LIFT WITH 4.5 t SWING ARM SUPPORT



- Very flat support height in the last segment
- 4.5 t swing arm lift for transporters and cars, with rubber support discs
- Support disc height adjustment using a thread and plug-in system

Load capacity	4,500 kg
Cylinder distance	1350 / 2300 / 2500 mm
Adjustable support discs	84 – 115 mm
Minimum support height	84 / 93 / 102 mm
Crunch and pinch point protection	CE stop, audible signal
Power unit kW / V / A	3 / 400 / 16

- 1 With large support area for lifting transporters and cars
- 2 Support arm restraints are automatically self-releasing at ground level, can be operated from above for readjustment
- 3 Low overall height thanks to the optimally manufactured swing arm support



Very flat extension for easy access to car lifting points.

## TWO-POST LIFT WITH 5.5 t SWING ARM SUPPORT



- High flexibility and safety thanks to MAHA support disc plug-in system
- Specially developed lift for large transporters

Load capacity	5,500 kg
Cylinder distance	1350 / 2300 / 2500 mm
Adjustable support discs	84 -115 mm
Minimum support height	104 / 113 / 122 mm
Crunch and pinch point protection	CE stop, audible signal
Power unit kW / V / A	3 / 400 / 16

- 1 Adapted swing arm carrier, traversable
- 2 Optimum swing arm extensions for lifting transporters



Safe support of vehicles by means of mobile column lift support also for 4.5 t lifts.

# TWO-POST LIFT WITH 6.5 t SWING ARM SUPPORT



- Swing arm lift for transporters, with rubber support discs
- Smooth-running swing arm extensions
- Support disc height adjustment using a thread and plug-in system

Load capacity	6,500 kg
Lifting height, max.	2017 mm
Lifting/lowering time, dependent on load, approx.	35 s
Cylinder distance	2700 mm
Adjustable support discs	101 – 137 mm
Minimum support height	109 / 124 / 144 mm
Crunch and pinch point protection	CE stop, audible signal
Power unit kW / V / A	3 / 400 / 16

- 1 With very large support area for lifting transporters
- 2 Optimum drive-on thanks to large cylinder distance (2700 mm)
- 3 Low overall height thanks to the optimally manufactured swing arm supports

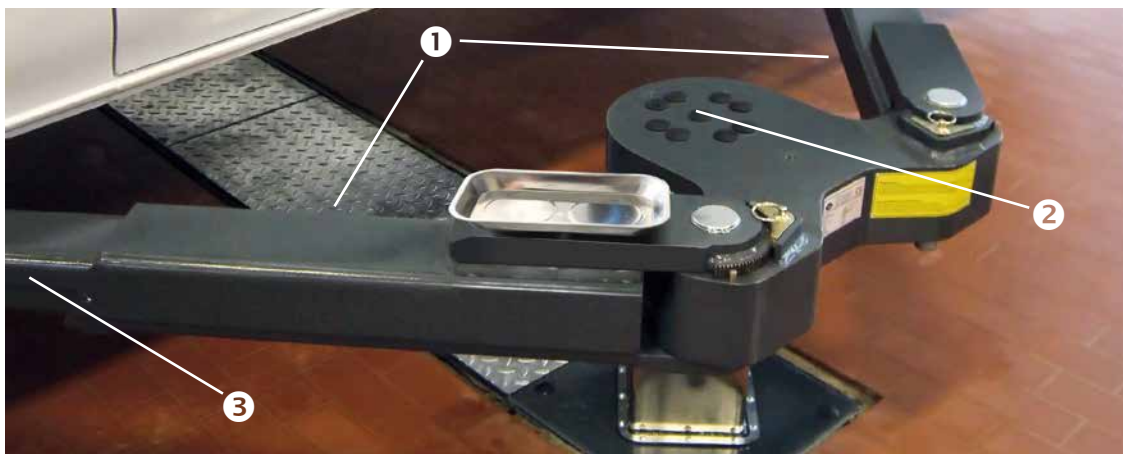

101 mm minimum height of support disc

# TWO-POST LIFT WITH RETRACTABLE SWING ARM SUPPORT

Suitable for standard loads of 3.5/4.5/5.5 t



Fully covered swing arm support, traversable with 2 t wheel load



Opening and closing of the cover is supported by a pneumatic damper system



Frame system with cover plate, fully hot-dip galvanised



With closed covers, the lift can be used as a standard lift

# TWO-POST LIFT WITH RUNWAY



## Runway lifts offer many advantages:

- Ample freedom of movement under the vehicle
- Space available for tool trolleys
- Light can reach under the vehicle and the lift
- Transparent customer dialogue is possible at the time of vehicle reception

## Configuration options:

Runway coating	Powder coating, granular coating or aluminium sheets
Runway models	Wooden, grid or steel running surfaces are possible
Runway installation	Flush-mounted, flush-mounted with floor compensation, mounting frame
Axle play tester	Standard or with removable prism jaws
Wheel alignment set	Runway supports, sliding plates
Compensating plates	For various applications

- 1 Ample freedom of movement thanks to floor compensation, especially suitable for dialogue with customers
- 2 All runways are equipped with axle lift rails (except modular runway)
- 3 Lighting on the inside of runways (optional)

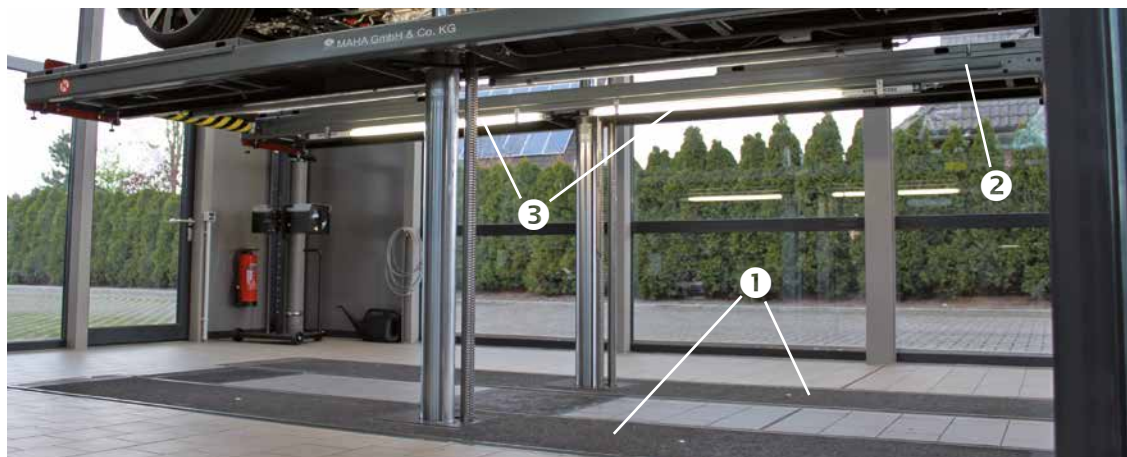

On the following pages, you will find different wheel-free jack designs.

## The right runway lift for any requirement



Attractive design for the customer area



Versatile for use as an inspection lift



Highly accurate as a wheel alignment lift



Plenty of space under the vehicle



Level workshop floor



Ample freedom of movement under the runway with high stability

## Professional workshop planning for efficient work

For example, the drive-on path is much shorter in the flush-mounted design

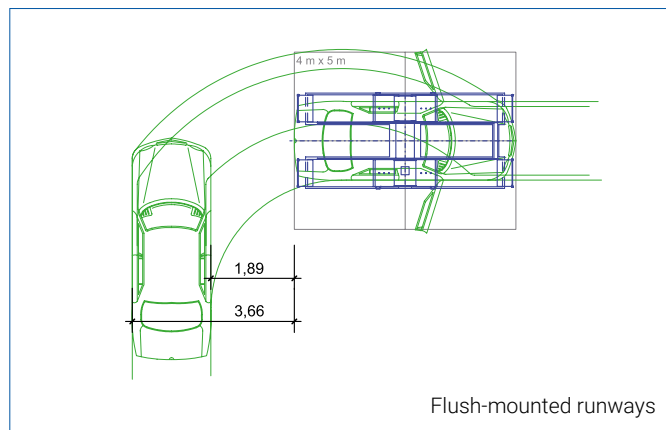
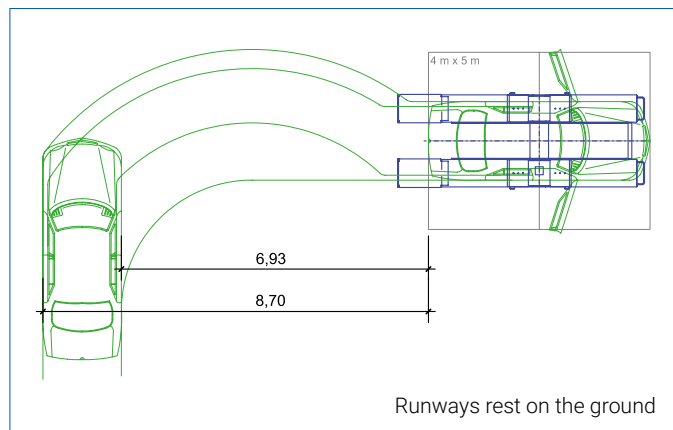

# MAESTRO LIFTING SITUATIONS



Fully lowered, making it easy to drive on with low ground clearance



Vehicle lifted by the wheels



Setting of wheel-free jack or wheel inspection from the side



Vehicle lifted by the sill

## The universal lifts with runways and full wheel-free jacking are two lifts in one

These lifts can be used for almost any kind of work in the workshop

### Vehicle reception lift:

These lifts are ideal for lifting the vehicle quickly by the wheels. The lifting points for wheel-free jacking can easily be adjusted. The fluorescent tubes in the runways ensure that there is sufficient light underneath the vehicle.

### Wheel alignment lift:

The runways can optionally be equipped with wheel alignment supports. These supports are attached to the runways under the wheels, allowing for very accurate lowering points. Our four-post in-ground lifts with latch locking system are optimal for quick measurements at all heights.

### Repair lift:

If the runways have been fully lowered, all work can be performed as on standard repair lifts. Flush-mounted runways are the ideal. If runways are left at half-height, they can also be used as workbenches.

## VS SQUARE II and ZS SQUARE II 6.5 lifting versions



Transporter workstation



# DRIVE-ON RAMPS AND ROLL-OFF PROTECTIONS

## Runways resting on the ground



Standard drive-on ramp



Folding drive-on ramp for high runways or low drive-on angle



Standard U-bracket retainers

## Flush-mounted runways



Drive-on ramp for flush-mounted runways



Automatic roll-off protection



Automatic folding roll-off protection



## Floor compensation for runway lifts



The floor compensation under the runway is a second ground surface, which levels off the surface below the lift.

## Mounting frame



Mounting frame for runway versions with or without floor compensation for accurate lift fitting. The prefabricated edging frames ensure high accuracy during installation.

# WHEEL-FREE JACKS ON RUNWAY LIFTS



Runway lifts with scissor wheel-free jack, sill support, load capacity: 3.5 t



Runway lifts with platform wheel-free jack, sill support, load capacity: 3.5 t



Runway lifts with flat head wheel-free jack, sill support, load capacity: 3.5 t

## Axle lift

An axle lift rail is mounted on all runways with exception of the modular runway. The opening for the axle lift is always included in the mounting frame for runways with floor compensation. A safety limit switch for the park position is installed in the delivery of the mounting frame mentioned above.



Axle lift AL II 2.0 / 2.6 PH, hydro-pneumatic with ergonomic controls (rotary handles) and air cooling set is included in the scope of delivery of axle lift orders.



Axle lift AL II 2.0/2.6 manual hydraulic

# AXLE PLAY TESTERS IN RUNWAY LIFTS

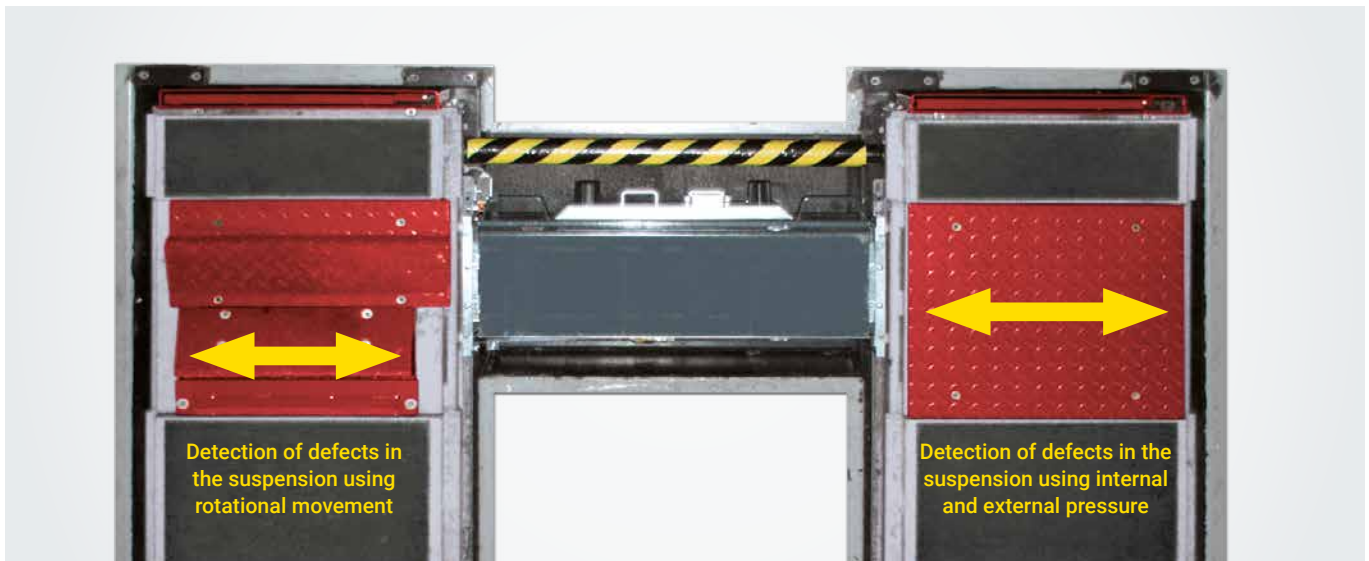

- Hydraulic drive with lift power unit
- High test forces and defined movement ranges of test plates
- Quick detection of defects and wear on steering parts, wheel bearings, spring system and suspension

## PMS 3/XL:

- In conjunction with MAHA headlight tester positioned in front of the lift
- All four wheel contact surfaces of the vehicle are at the same height
- Rear half of prism is automatically raised and lowered synchronously with the lift

## Lift lowered:

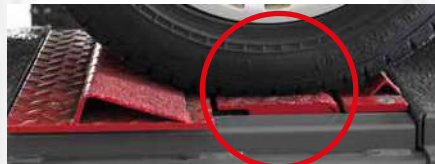

Rear half of the prism automatically lowered, all four wheel contact surfaces are at the same height

## Lift raised:

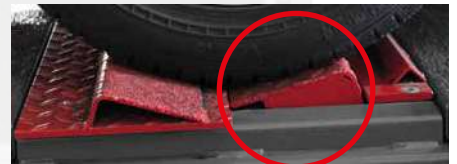

Rear half of the prism is automatically extended for axle inspection

## Radio hand lamp for axle play tester:

- Optimum handling thanks to small dimensions, L x W x H = 190 x 60 x 36 mm, light weight and ergonomic shape, non-slip, rubberised surface
- Housing has high breakage resistance
- LED hand lamp with high luminous efficiency and low power consumption
- 3.6 V DC / 2100 mAh high capacity rechargeable battery
- Variety of fastening and storage options, e.g. loops, clip and (detachable) magnet
- Robust membrane keypad with function keys



# RUNWAY LIFTS FOR WHEEL ALIGNMENT

## Runway support



Height adjustment at 1200 mm using wheel alignment supports. Telescopic wheel alignment supports, 1375 mm – 1700 mm (optional).



Safe and convenient storing of runway supports in the runway.



Fastening system and locking device for runway support.



## Modular compensating plate sets for runways

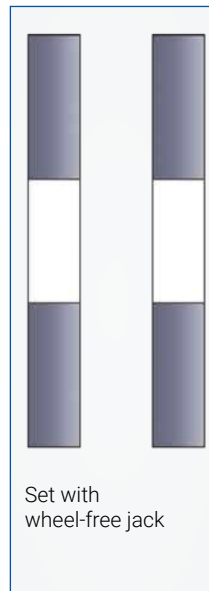
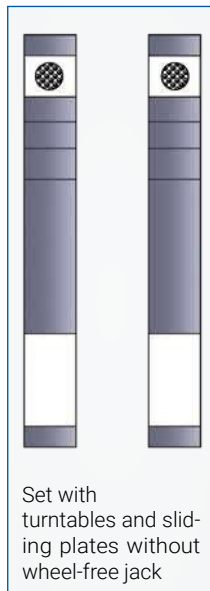
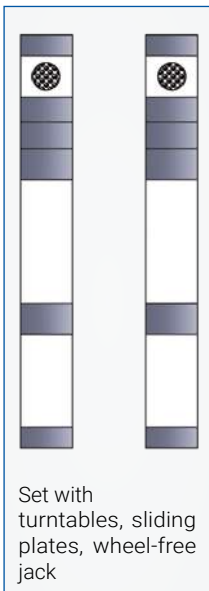

Compensating plate sets create a uniform drive-over level of the runways. Sets come with a non-slip coating.

## Sliding plates for wheel alignment



Sliding plates with transverse movement of 60 mm.



Precision sliding plate  
Minimal break-off torque of 5 Nm and minimal push force of 15 N, collection grooves for waste water.



The extended wheel-free jack can be let into the compensating plates continuously.

# RUNWAY SURFACE AND COATING

All runways are cleaned by means of steel grit blasting before coating (electrostatic powder coating) – thereafter a phosphate coating is applied. After assembly, the cavities are also preserved.

## Additional corrosion prevention measures include:

- Zinc spray (corrosion protection) and paint protection (mechanical wear)
- Special primer and paint protection (powder coating)

The following can be selected as an option:



Standard powder coating.

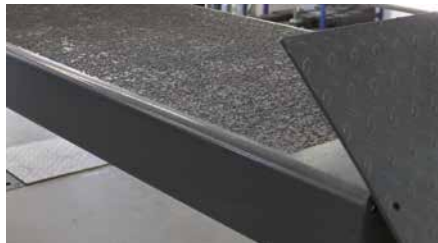

Powder coating with granulate wheel contact surface.



Runways with compensating plates for level adjustment to wheel-free jack or wheel alignment.



Runways with grating for washing bays and for use with studded tyres.



Runways with wooden coverage for durable wheel tread and cutting edge design.



Aluminium clad runways with folded edge for improved water run-off.

## Light under the vehicle!



Rotating LED lighting for easy adjustment of light direction for glare-free vision.

# ONE-POST LIFT WITH 3.0 t SWING ARM SUPPORT



- One-post swing arm lift with rubber support discs
- Anti-twist SQUARE II post
- Vehicle freely accessible in the sill and engine area
- Support disc height adjustment using a thread and plug-in system
- Support arm restraint is automatically self-releasing at ground level

Load capacity	3,000 kg
Adjustable support discs	78 – 109 mm
Crunch and pinch point protection	CE stop, audible signal
Power unit kW / V / A	3 / 400 / 16

- 1 Accurate positioning of the swing arm support discs
- 2 Easy drive-on thanks to narrow swing arm carrier (380 mm)
- 3 High flexibility and safety thanks to MAHA support disc plug-in system



Safe and smooth locking of support arms using a detent mechanism.

# ONE-POST LIFT WITH 3.0 t FLAT HEAD SUPPORT



- One-post lift with rubber-padded flat head supports
- Anti-twist SQUARE II post
- Robust lift with rigid assemblies
- Asymmetrical extensions with large lateral adjustability and low drive-on height
- Hot-dip galvanised support

Load capacity	3,000 kg
Extension range in latch steps	1400 – 2000 mm
Transverse support area	880 – 1820 mm
Rubber pad size	355 x 400 mm
Crunch and pinch point protection	CE stop, audible signal
Power unit kW / V / A	3 / 400 / 16

- 1 Extensions with surrounding chamfered runners
- 2 Grating for removal of water and dirt
- 3 Modular system in different extension versions



When equipment is used in washing and care areas, please note the recommended maintenance intervals.

# LIFT CONTROL

## Control on the wall



Control box installed to the wall (standard)



Control box flush-mounted (optional)



Membrane keypad with easy-to-operate micro-switches

## Control from the ceiling using E-BOX

Control in the E-BOX directly at the workstation. With CE declaration and connected 5-meter cable set.



Available upgrade versions: Data socket  
Socket, 16A, 400V  
2 additional 230-volt sockets

E-BOX version for DEUTRONIK, GYS-FLASH and ELTEK charging computer.

## Control via functional column and cable remote control



Control mounted to a functional column, for positioning as required



Control with cable remote control



Mounted to column